

Ventilationshuv

HU



Beskrivning

För utblåsning ovan tak.
Försedd med muffanslutning som passar utvändigt på ventilationskanal.

Dimensioner

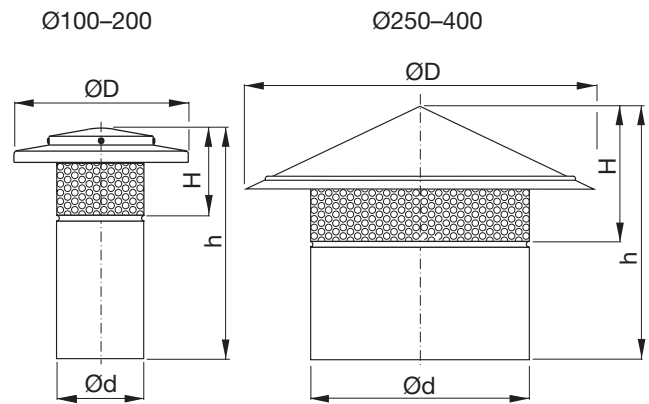

Ød nom	ØD [mm]	H [mm]	h [mm]	m kg	Passande takgenomföring TGR	
					50 mm	100 mm
					Storlek	
100	200	99	264	0,51	3	3
125	225	102	267	0,65	3	4
160	260	105	270	0,81	3	4
200	315	114	273	1,09	3	4
250	400	156	291	1,45	4	5
315	500	185	303	1,99	5	6
400	600	226	344	2,70	5	6

Tekniska data

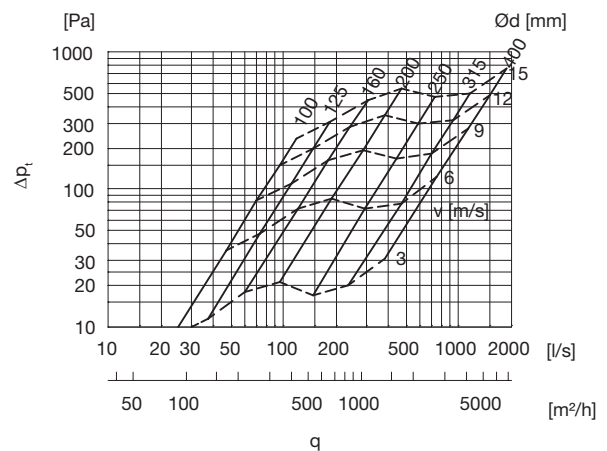









Beställningsexempel

Produkt **HU**
Dimension Ød **160**

Ventilationshuv

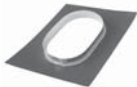
HU

Anslutningsschema

Takhuv					
Övre täckplåt med nippel, muff eller fläns				Runt takgenomföringen sitter:	
Takgenomföring				Överbeslag	
				Underbeslag	
				Fuktspärr	
				Fästprofil	
Undre täckplåt med nippel, muff eller fläns					
Ventilationskanal	